

CARACTERÍSTICAS

- columna troncocónica (conicidad 12,5%) de:
 - acero cor-ten (e=5mm); Ful-5 (e=4mm)
 - acero galvanizado (e=4mm); Ful-5 (e=3mm)
 soldadura con cordón continuo en atmosfera de argón.
- puertas de registro y cerramiento con llave de tubo rectangular.
- proyectores recomendados SIMON LIGHTING PR15+ y SIEMENS sicompact A mini color RAL 9006, reflector aluminio, optica asimétrica. Otros consultar.
- F-12: 254kg / F-10: 184kg / F-9: 159kg / F-7\10: 149kg / F-7\9: 162kg / F-5: 112kg

DISEÑO / DESIGN Jaume Artigues / Pere Cabrera

E 0 CM  150 CM

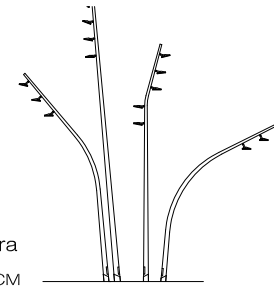

SERIE FUL®

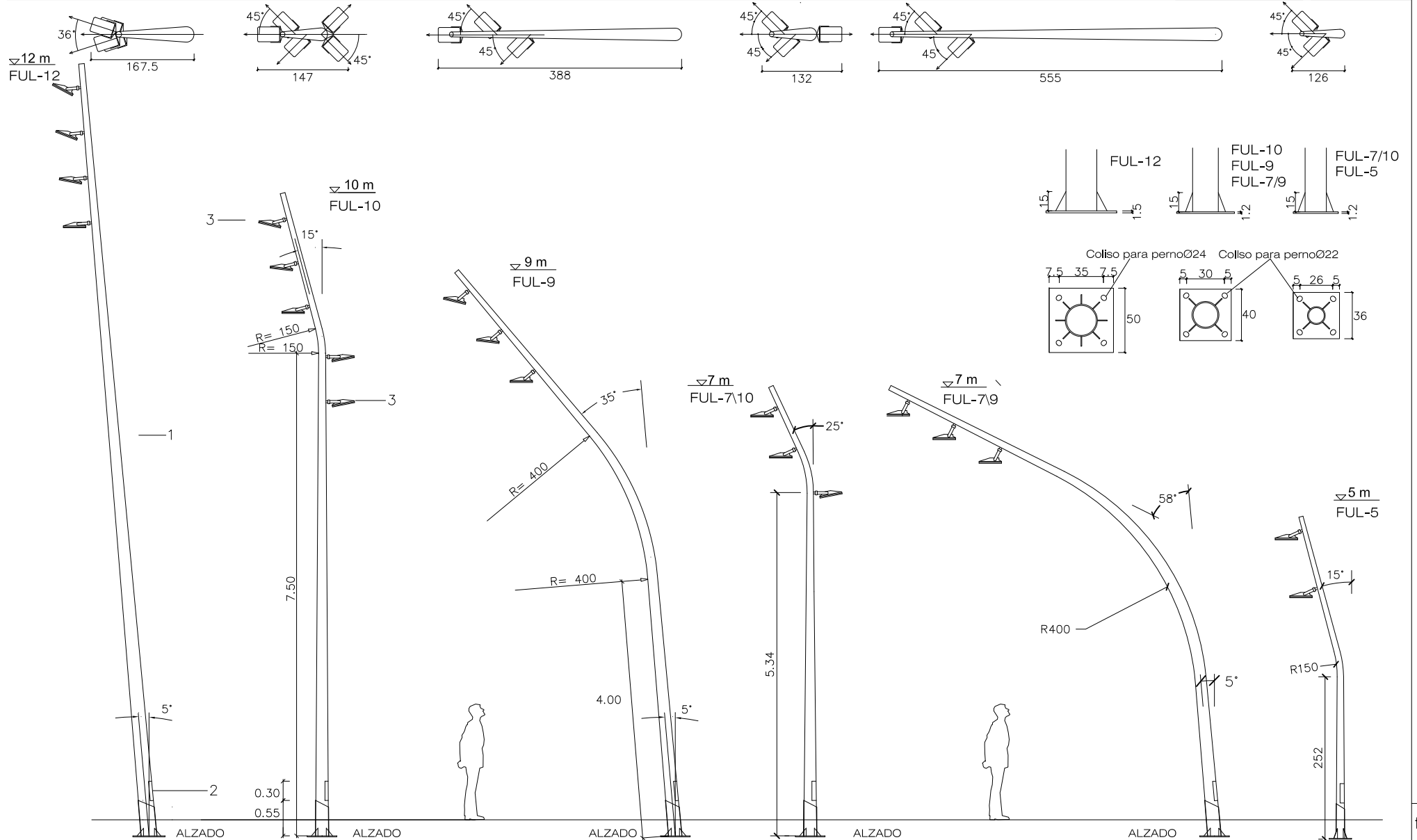

www.escofet.com

escofet

f.08a

CARACTERISTICAS

- tapered column (taper 12.5%) made of:
 - cor-ten steel (e=5mm); Ful-5 (e=4mm)
 - galvanized steel (e=4mm); Ful-5 (e=3mm)
 continuous seam weld in argon atmosphere
- inspection hatch and lock with rectangular tube key.
- floodlight recommended IEP PR-22AE and SIEMENS sicompact A mini color RAL 9006, aluminium reflector, asimétric optic. Consult other options.
- F-12: 254kg / F-10: 184kg / F-9: 159kg / F-7/10: 149kg / F-7/9: 162kg / F-5: 112kg

DISEÑO / DESIGN Jaume Artigues / Pere Cabrera

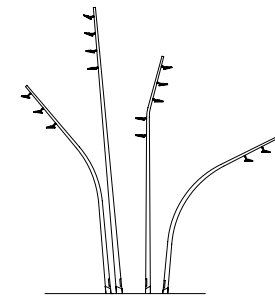

DETALLE CIMENTACIÓN COLUMNA TIPO Y TOMA DE TIERRA
Y TOMA DE TIERRA
DETAIL OF COLUMN FOUNDATION AND ELECTRICAL CONNECTION

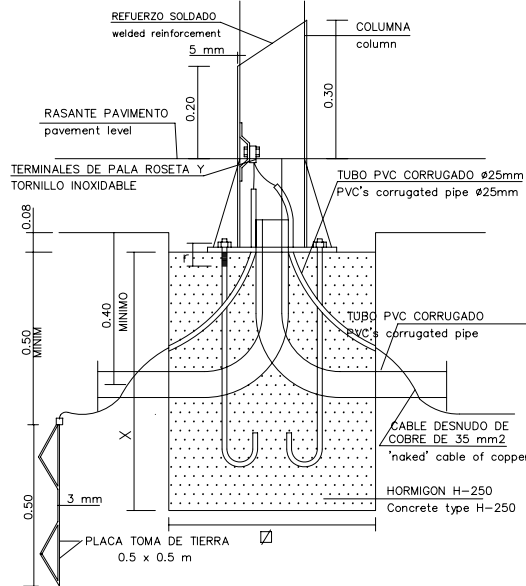

CIMENTACIÓN Y PERNOS
FOUNDATION AND SPIKES

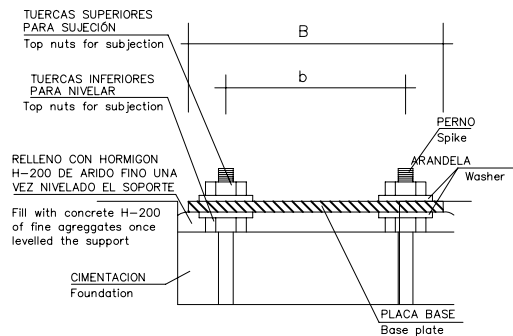

PROYECTORES
FLOODLIGHTS

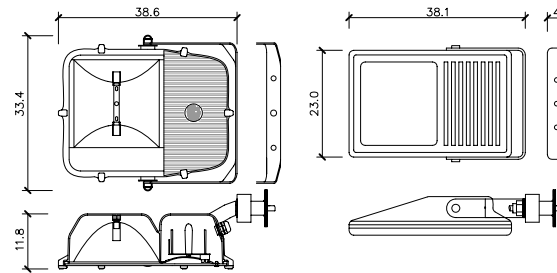

PROYECTOR IEP PR-22 AE

PROYECTOR SICOMPACT MINI A (siemens)

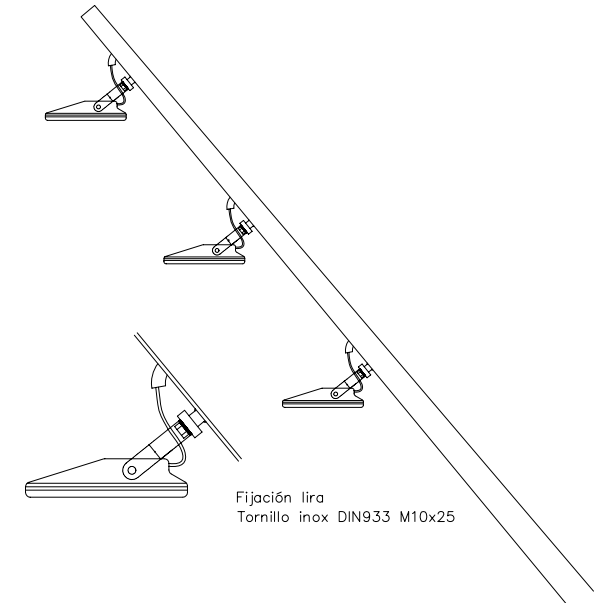

	FUL-12	FUL-10	FUL-9	FUL-7/10	FUL-7/9	FUL-5
COLUMNAS columns	H=12 m	H=10 m	H=9 m	H=7 m	H=7 m	H=5 m
ø SUP	88 mm	77 mm	77 mm	77 mm	77 mm	65 mm
ø INF	240 mm	200 mm	200 mm	165 mm	200 mm	130 mm
PUERTAS REGISTRO inspection hatch	1	1	1	1	1	1
P	300 mm	300 mm	300 mm	300 mm	300 mm	300 mm
M	150 mm	150 mm	150 mm	150 mm	150 mm	100 mm
CIMENTACIÓN foundation						
X (dim.aprox.)	120 cm	100 cm	80 cm	80 cm	80 cm	80 cm
ø	90 cm	80 cm	80 cm	80 cm	80 cm	80 cm
PLACA BASE base plate						
pernos(4)/spikes	M-24x800	M-22x700	M-22x700	M-22x700	M-22x700	M-22x700
r	130 mm	130 mm	110 mm	110 mm	110 mm	110 mm
cartelas/consolas	160mm(8)	150mm(4)	150mm(4)	150mm(4)	150mm(4)	150mm(4)
ø placa B/plate B	500 mm	400 mm	400 mm	350 mm	400 mm	360 mm
ø centros b/centers	350 mm	300 mm	300 mm	260 mm	300 mm	260 mm
E	15 mm	12 mm	12 mm	12 mm	12 mm	10 mm
PROYECTORES projectors	4	3 6 5	3	3	3	2
n° rótulas	4	3 6 5	3	3	3	2

